

CV-3002 (80*80*195CM):
fixed glass : 1950*237MM
Side panel : 1950*750MM

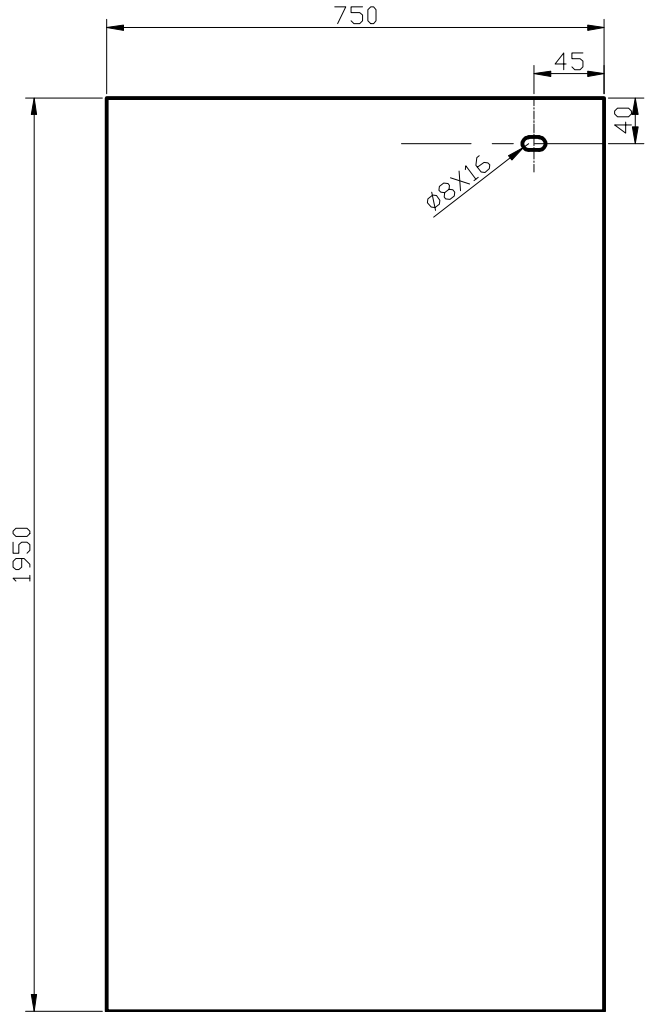

CV-3002 (90*90*195CM):
fixed glass : 1950*337MM
Side panel : 1950*850MM

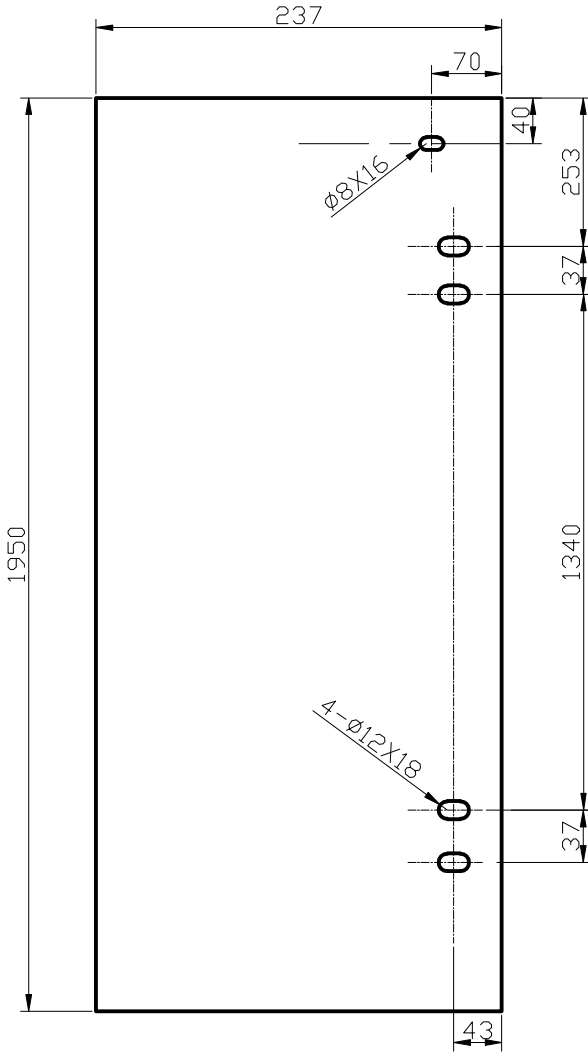
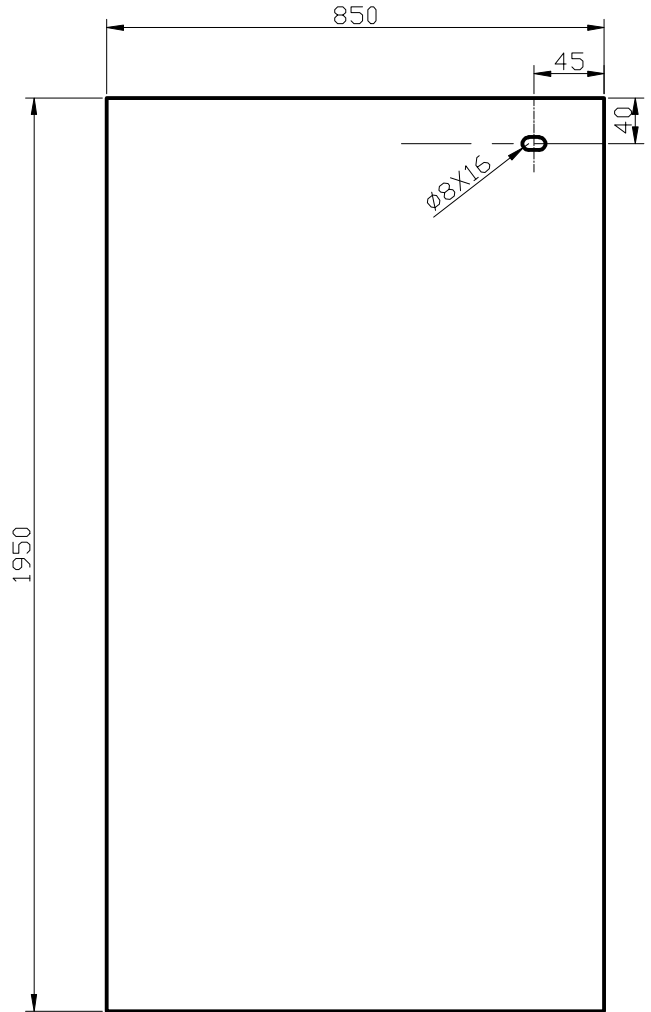
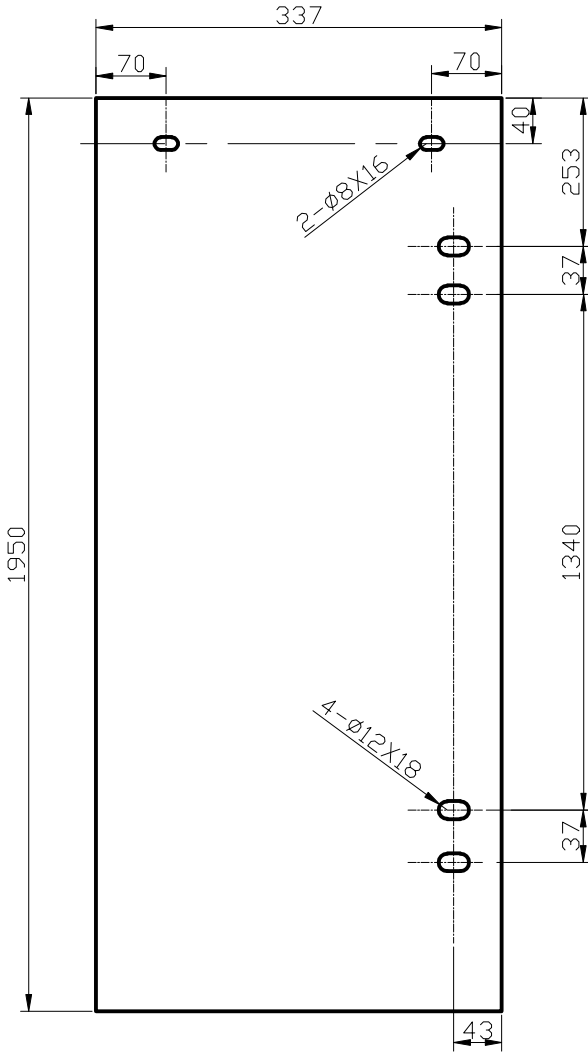

CV-3002 (100*80*195CM):
fixed glass : 1950*437MM
Side panel : 1950*750MM

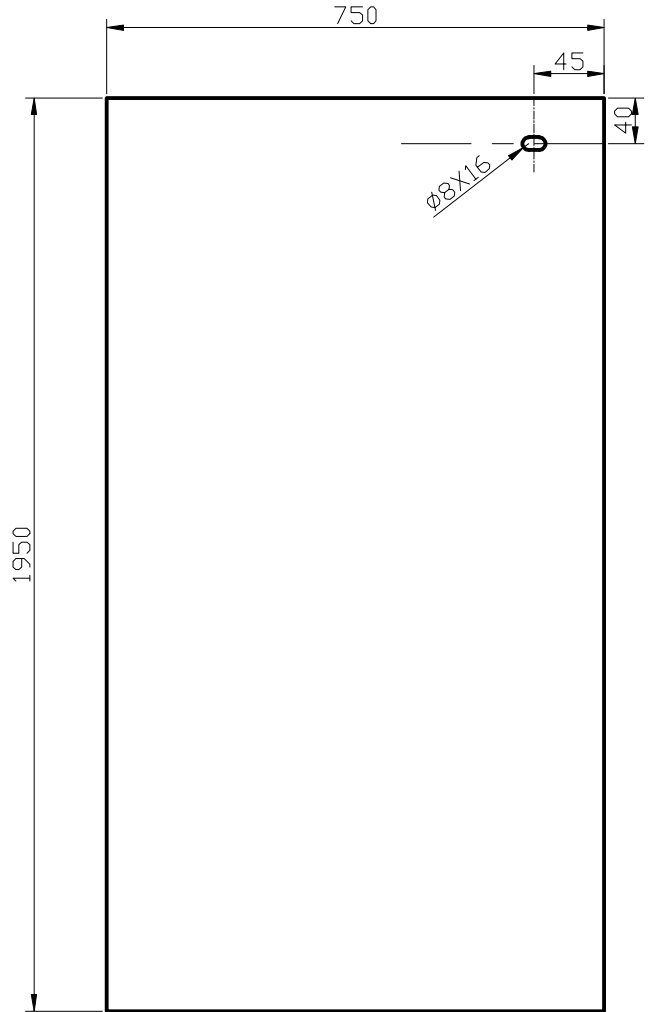
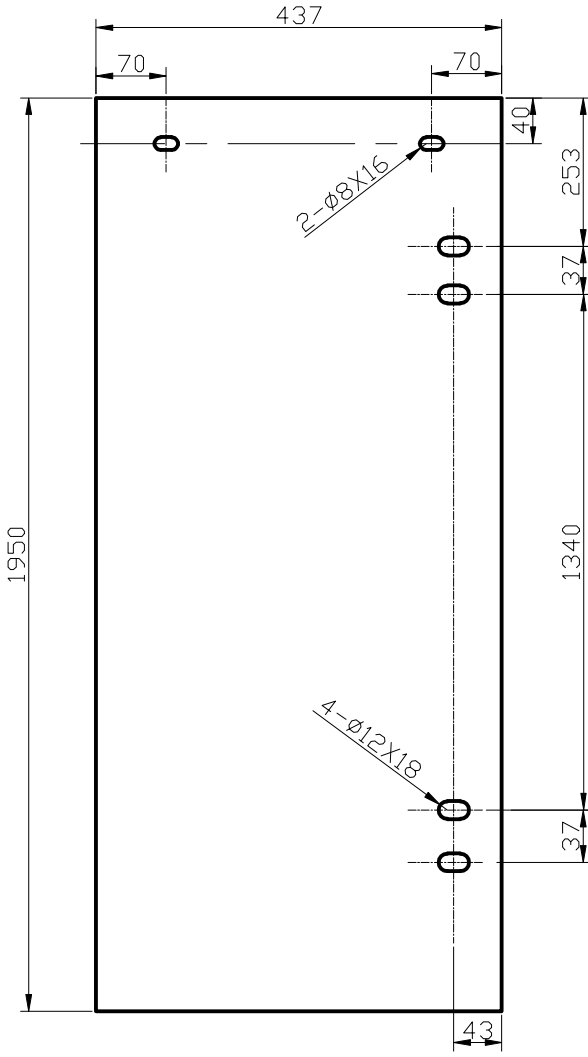

CV-3002 (80*80*195CM/90*90*195CM/100*80*195CM):
Door glass : 1923*508MM

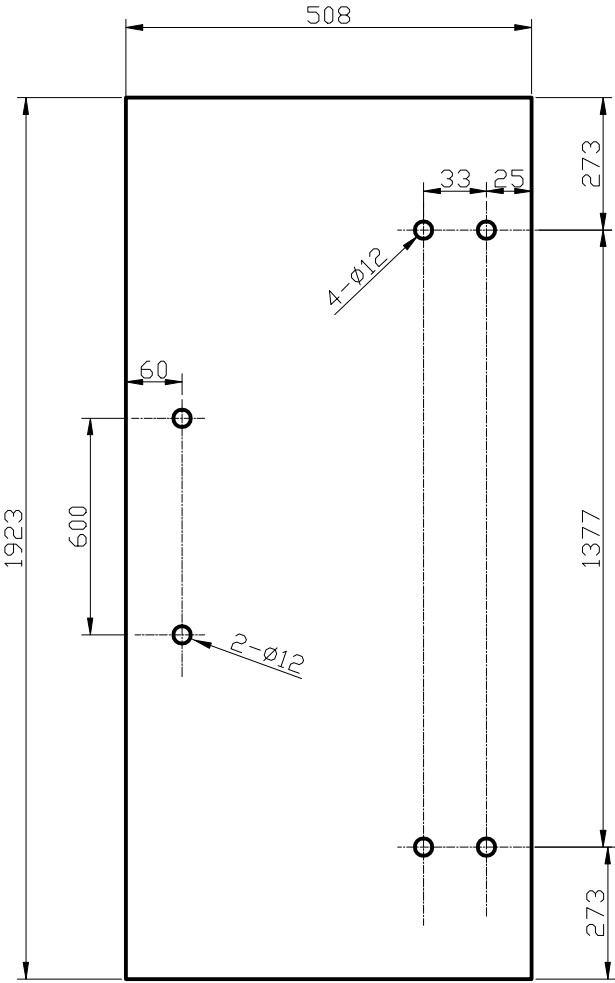

CV-3002 (120*80*195CM):
fixed glass : 1950*537MM
Side panel : 1950*750MM

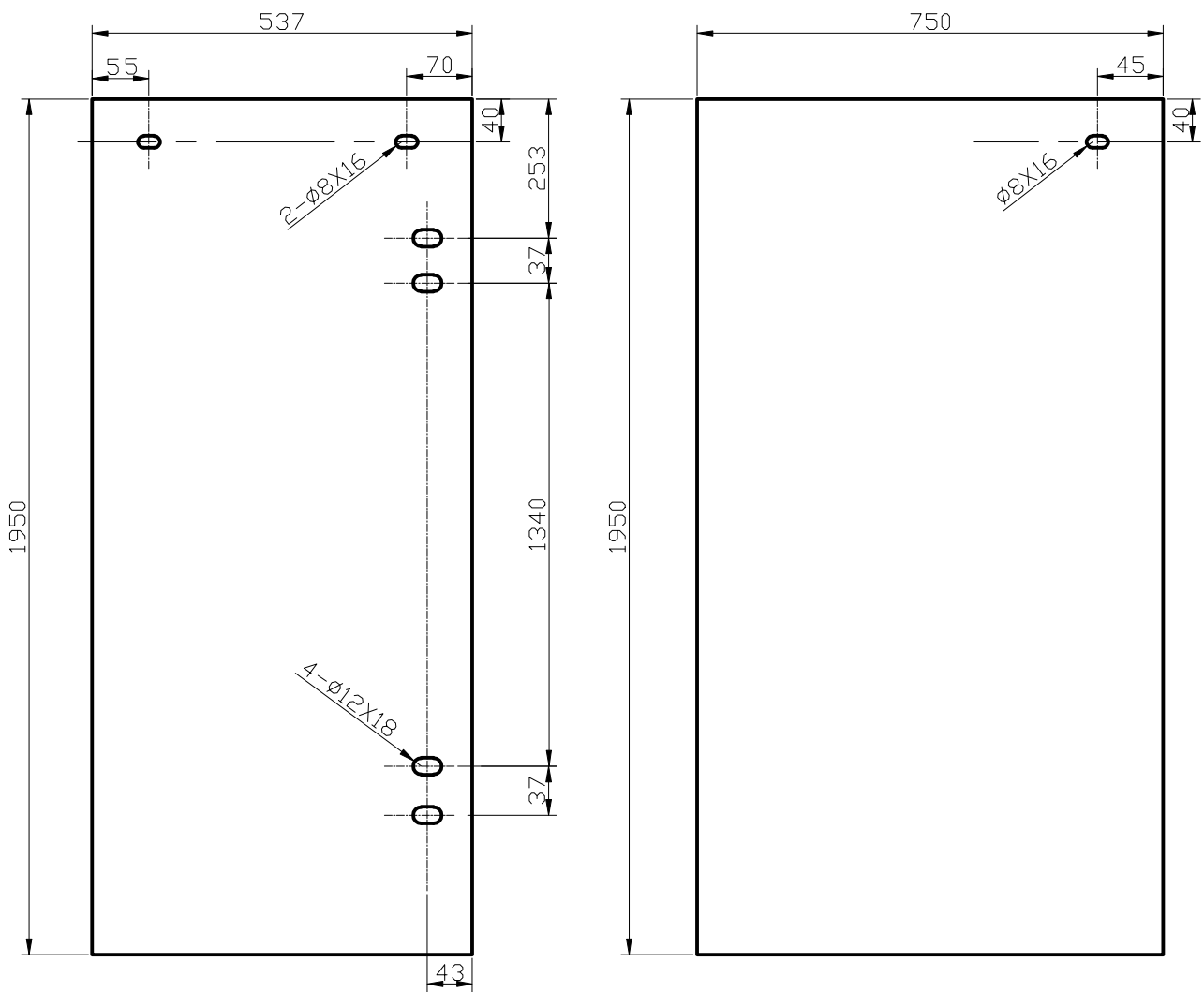

CV-3002 (120*80*195CM):
Door glass : 1923*608MM

